

Installation Instructions for
Digital Heating & Cooling

Model 700



Non-Programmable Thermostat

CONTENTS

Preparations 1
 Thermostat Details 1
 Removing Old Thermostat 1
 Mounting and Wiring 2
 Check Thermostat Operation 3
 Specifications 5
 Troubleshooting 5

YOUR THERMOSTAT REPLACES

Description	700
Standard Heat & Cooling Systems – 4 or 5 wires	Yes
Standard Heat Only Systems	Yes
Millivolt Heat Only Systems – Floor or Wall Furnaces	Yes
Standard Central Air Conditioning	Yes
Gas or Oil Heat	Yes
Electric Furnace	Yes
Hydronic (Hot Water) Zone Heat – 2 Wires	Yes
Hydronic (Hot Water) Zone Heat – 3 Wires	No
Heat Pump (No Aux or Emergency Heat)	Yes
Heat Pump (with Aux or Emergency Heat)	No
Baseboard Electric Heating or Line Voltage (120 or 240 volt)	No

1 PREPARATIONS

Assemble tools required as shown below.

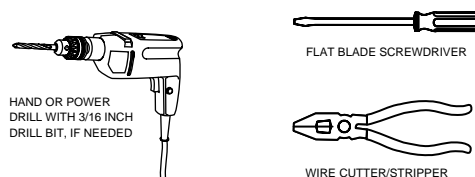

Failure to follow and read all instructions carefully before installing or operating this control could cause personal injury and/or property damage

2 THERMOSTAT DETAILS

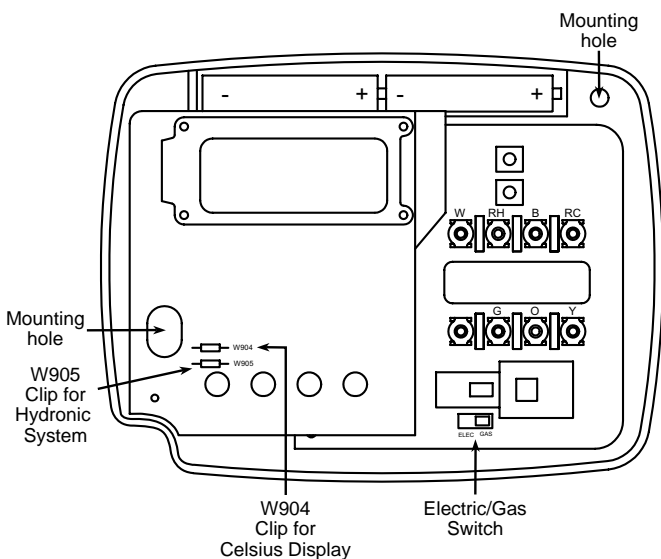

Figure 1. Thermostat base

3 REMOVING OLD THERMOSTAT

CAUTION
 To prevent electrical shock and/or equipment damage, disconnect electrical power to the system at the main fuse or circuit breaker until installation is complete.

Before removing wires from old thermostat's switching subbase, **label each wire** with the terminal designation it was removed from.

- Remove Old Thermostat:** A standard heat/cool thermostat consists of three basic parts:
 - The cover, which may be either a snap-on or hinge type.
 - The base, which is removed by loosening all captive screws.
 - The switching subbase, which is removed by unscrewing the mounting screws that hold it on the wall or adaptor plate.
- Shut off electricity at the main fuse box until installation is complete. Ensure that electrical power is disconnected.
- Remove the front cover of the old thermostat. **With wires still attached**, remove wall plate from the wall. If the old thermostat has a wall mounting plate, remove the thermostat and the wall mounting plate as an assembly.
- Identify each wire attached to the old thermostat using the labels enclosed with the new thermostat.**
- Disconnect the wires from the old thermostat one at a time. **DO NOT LET WIRES FALL BACK INTO THE WALL.**
- Install new thermostat using the following procedures.

3 REMOVING OLD THERMOSTAT

CONTINUED FROM FIRST PAGE

ATTENTION! This product does not contain mercury. However, this product may replace a unit which contains mercury.

Do not open mercury cells. If a cell becomes damaged, do not touch any spilled mercury. Wearing non-absorbent gloves, take up the spilled mercury and place into a container which can be sealed. If a cell becomes damaged, the unit should be discarded.

Mercury must not be discarded in household trash. When the unit this product is replacing is to be discarded, place in a suitable container and return to White-Rodgers at 2895 Harrison Street, Batesville, AR 72501-2117 for proper disposal.

4 MOUNTING AND WIRING

⚠ WARNING

Do not use on circuits exceeding specified voltage. Higher voltage will damage control and could cause shock or fire hazard.

Do not short out terminals on gas valve or primary control to test. Short or incorrect wiring will damage thermostat and could cause personal injury and/or property damage.

Thermostat installation and all components of the system shall conform to Class II circuits per the NEC code.

Electric Heat or Single-Stage Heat Pump Systems

This thermostat is configured from the factory to operate a heat/cool, fossil fuel (gas, oil, etc.), forced air system. It is configured correctly for any system that DOES NOT require the thermostat to energize the fan on a call for heat. If your system is an electric or heat-pump system that REQUIRES the thermostat to turn on the fan on a call for heat, locate the **GAS/ELECTRIC** switch (see fig. 1) and switch it to the **ELECTRIC** position. This will allow the thermostat to energize the fan immediately on a call for heat. If you are unsure if the heating/cooling system requires the thermostat to control the fan, contact a qualified heating and air conditioning service person.

Hydronic (Hot Water or Steam) Heating Systems

This thermostat is set to operate properly with a forced-air heating system. If you have a hydronic heating system (a system that heats with hot water or steam), you must set the thermostat to operate properly with your system.

The factory default setting is forced air heat. Clipping jumper W905 on the circuit board will produce a longer heating cycle which is normally for hot water or steam (hydronic) systems. Both settings produce a very accurate temperature control and can be set to your personal preference. As received, the thermostat cycles the system just under 1°F. With W905 clipped, the system cycles at approximately 1.5°F.

⚠ CAUTION

Take care when securing and routing wires so they do not short to adjacent terminals or rear of thermostat. Personal injury and/or property damage may occur.

TERMINAL CROSS REFERENCE CHART

New Thermostat Terminal Designation	Other Manufacturers' Terminal Designation				
RH	4	RH	M	R5	R
RC	R	R	V	-	-
G	G	G	F	G	G
W	W	W	H	4	W
Y	Y	Y	C	Y6	Y

* These are four-wire, single-transformer systems. Factory installed jumper wire between the **RH** and **RC** terminals must remain in place.

Attach Thermostat Base to Wall

1. Remove the packing material from the thermostat. Gently pull the cover straight off the base. Forcing or prying on the thermostat will cause damage to the unit. If necessary, move the electric heat switch (see **ELECTRIC HEAT SYSTEMS**, above).
2. Connect wires beneath terminal screws on base using appropriate wiring schematic (see figs. 2 through 7).
3. Place base over hole in wall and mark mounting hole locations on wall using base as a template.
4. Move base out of the way. Drill mounting holes.
5. Fasten base loosely to wall, as shown in fig. 1, using two mounting screws. Adjust until level, and then tighten screws. (Leveling is for appearance only and will not affect thermostat operation.) If you are using existing mounting holes, or if holes drilled are too large and do not allow you to tighten base snugly, use plastic screw anchors to secure subbase.
6. Push excess wire into wall and plug hole with a fire-resistant material (such as fiberglass insulation) to prevent drafts from affecting thermostat operation.

Battery Location

This thermostat requires 2 "AAA" alkaline batteries to operate. If "**LO BATTERY**" is displayed, the batteries are low and should be replaced with fresh "AAA" Energizer® alkaline batteries. To replace the batteries, install the batteries along the top of the base (see fig. 1). The batteries must be installed with the positive(+) ends to the right.

4 MOUNTING AND WIRING

CONTINUED FROM SECOND PAGE

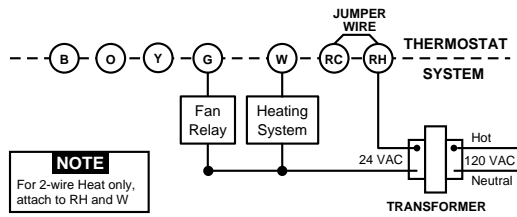

NOTE
For 2-wire Heat only,
attach to RH and W

Figure 2. Typical wiring diagram for heat only, 3-wire, single transformer systems

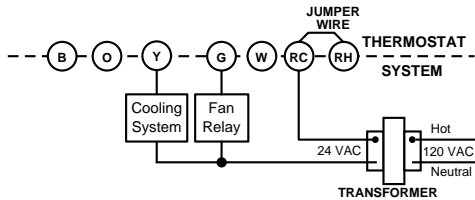
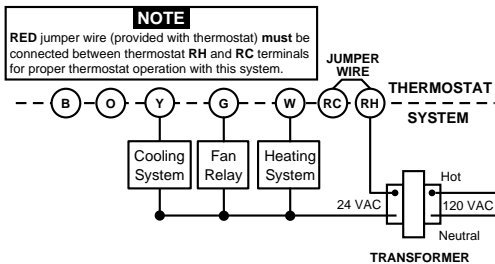

Figure 3. Typical wiring diagram for cool only, 3-wire, single transformer systems



NOTE
RED jumper wire (provided with thermostat) must be connected between thermostat RH and RC terminals for proper thermostat operation with this system.

Figure 4. Typical wiring diagram for heat/cool, 4-wire, single transformer systems

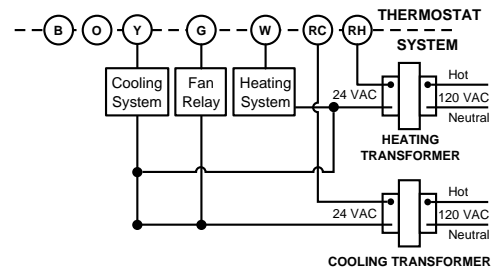
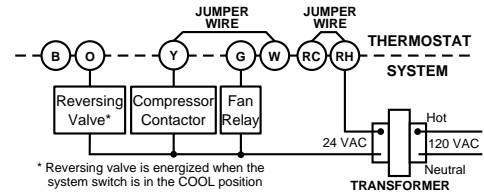
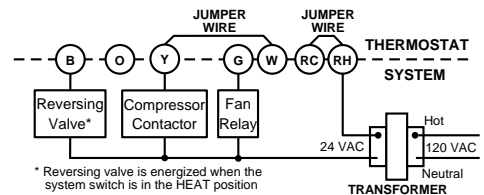

Figure 5. Typical wiring diagram for heat/cool, 5-wire, two-transformer systems



* Reversing valve is energized when the system switch is in the COOL position

Figure 6. Typical wiring diagram for heat pump with reversing valve energized in COOL



* Reversing valve is energized when the system switch is in the HEAT position

Figure 7. Typical wiring diagram for heat pump with reversing valve energized in HEAT

5 CHECK THERMOSTAT OPERATION

NOTE

To prevent static discharge problems, touch side of thermostat to release static build-up before touching any keys.

If at any time during testing your system does not operate properly, contact a qualified serviceperson.

Fan Operation

If your system **does not** have a **G** terminal connection, skip to **Heating System**.



1. Turn on power to the system.
2. Move FAN switch to **ON** position. The blower should begin to operate.
3. Move FAN switch to **AUTO** position. The blower should stop immediately.

Cooling System



CAUTION

To prevent compressor and/or property damage, if the outdoor temperature is below 50°F, DO NOT operate the cooling system.

This thermostat has a time delay between cooling cycles to allow the head pressure in the compressor to stabilize. If the temperature is adjusted to call for cool within 5 minutes of the last cycle the snowflake icon will blink indicating the thermostat is locked out. After 3 to 5 minutes, the compressor will start and the snowflake icon will stop flashing. This helps prevent the compressor from cycling too quickly and is normal operation for the thermostat.

1. Move SYSTEM switch to **COOL** position.
2. Press  to adjust thermostat setting below room temperature. The blower should come on immediately on high speed, followed by cold air circulation
3. Press  to adjust temperature setting above room temperature. The cooling system should stop operating.

Heating System

1. Move SYSTEM switch to **HEAT** position. If the heating system has a standing pilot, be sure to light it.
2. Press  to adjust thermostat setting above room temperature. The heating system should begin to operate.
3. Press  to adjust temperature setting below room temperature. The heating system should stop operating.

5 CHECK THERMOSTAT OPERATION



CONTINUED FROM THIRD PAGE

Before you begin using your thermostat, you should be familiar with its features and with the display and the location and operation of the thermostat buttons. Your thermostat consists of two parts: the **thermostat cover** and the **base**. To remove the cover, gently pull it straight out from the base. To replace the cover, line up the cover with the base and press gently until the cover snaps onto the base.

The Thermostat Buttons and Switches



- ① (Up arrow) Raises temperature setting.
- ② (Down arrow) Lowers temperature setting.
- ③ FAN switch (**ON**, **AUTO**).
- ④ SYSTEM switch (**COOL**, **OFF**, **HEAT**).

The Display

- ⑤  is displayed when the SYSTEM switch is in the **HEAT** position.  is displayed (non-flashing) when the SYSTEM switch is in the **COOL** position.  is displayed (flashing) when the compressor is in lockout mode.
- ⑥ Displays current temperature.
- ⑦ “**LO BATTERY**” is displayed when the 2 “AAA” batteries are low and should be replaced. Nothing else will be displayed.
- ⑧ Displays currently set temperature (this is blank when SYSTEM switch is in the **OFF** position).

Operating Features

Now that you are familiar with the thermostat buttons and display, read the following information to learn about the many features of the thermostat.

- **SIMULTANEOUS HEATING/COOLING SETPOINT STORAGE** — You can enter both your heating and cooling setpoints at the same time. There is no need to re-enter the thermostat at the beginning of each season.
- **TEMPERATURE SETTING** — Press  or  until the display shows the temperature you want. The thermostat will keep the room temperature at the selected temperature.
- **°F/°C CONVERTIBILITY** — The factory default setting is Fahrenheit. Clipping W904 jumper on the circuit board (see fig. 1) will alter this feature to Celsius temperature setting.
- **LOW BATTERY INDICATOR** — If the 2 “AAA” alkaline batteries are low and should be replaced, the display will be blank except for “**LO BATTERY**”. When the batteries are low, pressing any button will cause the display to operate for ten seconds. After ten seconds, the display will be blank except for “**LO BATTERY**”. After “**LO BATTERY**” has been displayed for 4 weeks, the thermostat will raise the temperature 10° above your setpoint in **COOL** mode and drop the temperature 10° below your setpoint in **HEAT** mode. You cannot program with low batteries, but you can override setpoint temperature.

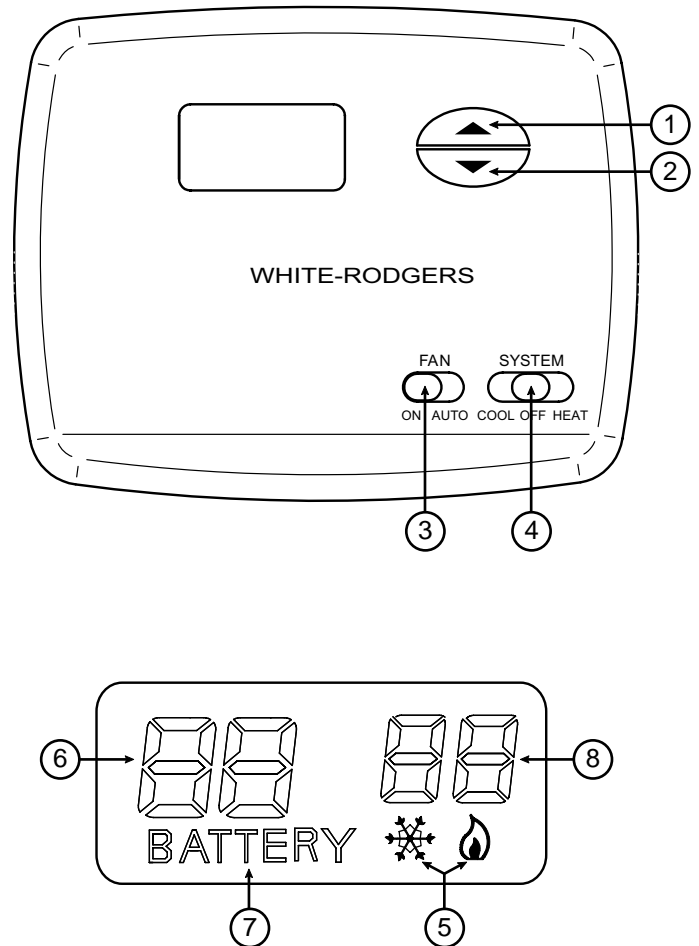









Figure 8. Thermostat display, buttons, and switches

- **TEMPERATURE DISPLAY ADJUSTMENT** — Your new thermostat has been accurately set in our factory. However, if you wish, you may adjust your new thermostat temperature display to match your old thermostat. This can be accomplished (within a $\pm 3^\circ$ range) as follows:
 1. Press  or  at the same time for two seconds with the SYSTEM switch in **OFF** position.
 2. Press  or  to adjust the displayed temperature to your desired setting.
 3. Move SYSTEM switch from **OFF** to exit the feature.
- **DISPLAY BACKLIGHT** — (Not available on earlier models.) The display backlight improves display contrast in low lighting conditions. Selecting backlight ON will turn the light on for a short period of time after any button is pressed. Selecting backlight OFF (default) will keep the light off. Turn the display backlight feature ON as follows:
 1. Press  and  at the same time for two seconds with the SYSTEM switch in **HEAT** position. The display will alternately show “**-L**” AND “**FF**” (**off**).
 2. Press  or  to change “**FF**” to “**ON**”.
 3. Move SYSTEM switch to **OFF** to exit the feature.

6 SPECIFICATIONS

ELECTRICAL DATA

Electrical Rating:

0 to 30 VAC 50/60 Hz. or D.C.

0.05 to 1.0 Amps (Load per terminal)

1.5 Amps Maximum Total Load (All terminals combined)

THERMAL DATA

Setpoint Temperature Range:

45°F to 90°F (7°C to 32°C)

Operating Ambient Temperature Range:

32°F to 105°F

Operating Humidity Range:



0 to 90% RH (non-condensing)

Shipping Temperature Range:

-40°F to 150°F

7 TROUBLESHOOTING

Reset Operation

If a voltage spike or static discharge blanks out the display or causes erratic thermostat operation you can reset the thermostat by pressing  and  at the same time while moving the SYSTEM switch from **OFF** to **HEAT**. This also resets the factory defaults. If the thermostat has power, has been reset

and still does not function correctly contact your heating/cooling service person or place of purchase.

Batteries

For optimum performance, we recommend replacing batteries once a year with fresh "AAA" Energizer® alkaline batteries.

Symptom	Possible Cause	Corrective Action
No Heat/No Cool/No Fan (common problems)	<ol style="list-style-type: none"> Blown fuse or tripped circuit breaker. Furnace power switch to OFF. Furnace blower compartment door or panel loose or not properly installed. 	<p>Replace fuse or reset breaker. Turn switch to ON. Replace door panel in proper position to engage safety interlock or door switch.</p>
No Heat	<ol style="list-style-type: none"> Pilot light not lit. SYSTEM Switch not set to HEAT. Loose connection to thermostat or system. Furnace Lock-Out Condition. Heat may also be intermittent. Heating system requires service or thermostat requires replacement. 	<p>Re-light pilot. Set SYSTEM Switch to HEAT and raise setpoint temperature above room temperature. Verify thermostat and system wires are securely attached. Many furnaces have safety devices that shut down when a lock-out condition occurs. If the heat works intermittently contact the furnace manufacturer or local service person for assistance. Diagnostic: Set SYSTEM Switch to HEAT and raise the setpoint above room temperature. Within a few seconds the thermostat should make a soft click sound. This sound usually indicates the thermostat is operating properly. If the thermostat does not click, try the reset operation listed below. If the thermostat does not click after being reset contact your heating and cooling service person or place of purchase for a replacement. If the thermostat clicks, contact the furnace manufacturer or a service person to verify the heating is operating correctly.</p>
No Cool	<ol style="list-style-type: none"> SYSTEM Switch not set to Cool. Loose connection to thermostat or system. Cooling system requires service or thermostat requires replacement. 	<p>Set SYSTEM Switch to COOL and lower setpoint temperature below room temperature. Verify thermostat and system wires are securely attached. Same procedure as diagnostic for No Heat condition except set the thermostat to COOL and lower the setpoint below the room temperature. There may be up to a five minute delay before the thermostat clicks in Cooling.</p>

7 TROUBLESHOOTING

CONTINUED FROM FIFTH PAGE

Symptom	Possible Cause	Corrective Action
Heat, Cool or Fan Runs Constantly.	<ol style="list-style-type: none"> 1. Possible short in wiring. 2. Possible short in thermostat. 3. Possible short in heat/cool/fan system. 4. FAN Switch set to Fan ON. 	Check each wire connection to verify they are not shorted or touching together. No bare wire should stick out from under terminal screws. Try resetting the thermostat as described above. If the condition persists the manufacturer of your system or service person can instruct you on how to test the Heat/Cool system for correct operation. If the system operates correctly, replace the thermostat.
Furnace Cycles Too Fast or Too Slow (narrow or wide temperature swing)	<ol style="list-style-type: none"> 1. The location of the thermostat and/or the size of the Heating System may be influencing the cycle rate. 	Digital thermostats normally provide precise temperature control and may cycle faster than some older mechanical models. A faster cycle rate means the unit turns on and off more frequently but runs for a shorter time so there is no increase in energy use. If you would like to increase the cycle time, clip Jumper W-905 as mentioned in the instructions for Hydronic Heating Systems. It is not possible to shorten the cycle time. If an acceptable cycle rate is not achieved as received or by clipping W-905 contact a local service person for additional suggestions.
Cooling Cycles Too Fast or Too Slow (narrow or wide temperature swing)	<ol style="list-style-type: none"> 1. The location of the thermostat and the size of the Cooling System can influence the cycle rate. 	The cycle rate for cooling is fixed and can not be adjusted. Contact a local service person for suggestions.
Thermostat Setting and Thermostat Thermometer Disagree	<ol style="list-style-type: none"> 1. Thermostat thermometer setting requires adjustment. 	The thermometer can be adjusted +/- 3 degrees. See Temperature Display Adjustment in the Operation section.
Blank Display and/or Keypad Not Responding	<ol style="list-style-type: none"> 1. Voltage spike or static discharge. 2. Battery change required. 	Replace batteries and check heat/cool system for proper operation. If a voltage spike occurs use the Reset Operation listed above.